

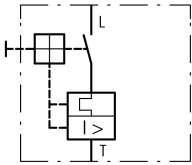



Motor-protective circuit-breaker, 3p, Ir=4-6.3A

Part no. PKZM01-6,3
Catalog No. 278483
Eaton Catalog No. XTPB6P3BC1
EL-Nummer (Norway) 0004365018

Delivery program

Product range				PKZM01 motor protective circuit-breakers up to 16 A with pushbutton actuation
Basic function				Motor protection
				
Notes				Also suitable for motors with efficiency class IE3. IE3-ready devices are identified by the logo on their packaging.
Connection technique				Screw terminals
Contact sequence				
Max. motor rating				
AC-3				
220 V 230 V 240 V	P	kW		1.1
380 V 400 V 415 V	P	kW		2.2
440 V	P	kW		3
500 V	P	kW		3
660 V 690 V	P	kW		4
Rated uninterrupted current	I_u	A		6.3
Setting range				
Overload releases		I_r	A	4 - 6.3
short-circuit release				
max.	I_{rm}	A		97.7
Phase-failure sensitivity				IEC/EN 60947-4-1, VDE 0660 Part 102
Notes Overload trigger: tripping class 10 A Can be snapped on to IEC/EN 60715 top-hat rail with 7.5 or 15 mm height.				

Technical data

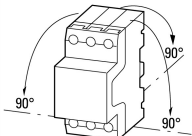
General				
Standards				IEC/EN 60947, VDE 0660, UL, CSA
Climatic proofing				Damp heat, constant, to IEC 60068-2-78 Damp heat, cyclic, to IEC 60068-2-30
Ambient temperature				
Storage		°C		- 40 - 80
Open		°C		-25 - +55
Enclosed		°C		- 25 - 40
Mounting position				
Direction of incoming supply				as required

Degree of protection			
Device			IP20
Terminations			IP00
Protection against direct contact when actuated from front (EN 50274)			Finger and back-of-hand proof
Mechanical shock resistance half-sinusoidal shock 10 ms to IEC 60068-2-27		g	25
Altitude		m	Max. 2000
Terminal capacity main cable			
Screw terminals			
Solid		mm ²	1 x (1 - 6) 2 x (1 - 6)
Flexible with ferrule to DIN 46228		mm ²	1 x (1 - 6) 2 x (1 - 6)
Solid or stranded		AWG	18 - 10
Stripping length		mm	10
Specified tightening torque for terminal screws			
Main cable		Nm	1.7

Main conducting paths

Rated impulse withstand voltage	U_{imp}	V AC	6000
Overvoltage category/pollution degree			III/3
Rated operational voltage	U_e	V AC	690
Rated uninterrupted current = rated operational current	$I_u = I_e$	A	6.3
Rated frequency	f	Hz	40 - 60
Current heat loss (3 pole at operating temperature)		W	5.68
Lifespan, mechanical	Operations	$\times 10^6$	0.05
Lifespan, electrical (AC-3 at 400 V)			
Lifespan, electrical	Operations	$\times 10^6$	0.05
Max. operating frequency		Ops/h	25
Short-circuit rating			
DC			
Short-circuit rating		kA	60
Notes			up to 250 V
Motor switching capacity			
AC-3 (up to 690V)		A	6.3
DC-5 (up to 250V)		A	6.3 (3 contacts in series)

Trip blocks

Temperature compensation			
to IEC/EN 60947, VDE 0660		°C	- 5 ... 40
Operating range		°C	- 25 ... 55
Temperature compensation residual error for $T > 40$ °C			≤ 0.25 %/K
Setting range of overload releases		$\times I_u$	0.6 - 1
short-circuit release			Basic device, fixed: $15.5 \times I_u$
Short-circuit release tolerance			± 20 %
Phase-failure sensitivity			IEC/EN 60947-4-1, VDE 0660 Part 102

Rating data for approved types

Switching capacity			
Maximum motor rating			
Three-phase			
200 V 208 V		HP	1
230 V 240 V		HP	1.5
460 V 480 V		HP	3
575 V 600 V		HP	5
Single-phase			
115 V 120 V		HP	0.25

230 V 240 V	HP	0.5
Short Circuit Current Rating, group protection	SCCR	
600 V High Fault		
SCCR (fuse)	kA	50
max. Fuse	A	600
SCCR (CB)	kA	50
max. CB	A	600

Design verification as per IEC/EN 61439

Technical data for design verification			
Rated operational current for specified heat dissipation	I_n	A	6.3
Heat dissipation per pole, current-dependent	P_{vid}	W	0
Equipment heat dissipation, current-dependent	P_{vid}	W	5.68
Static heat dissipation, non-current-dependent	P_{vs}	W	0
Heat dissipation capacity	P_{diss}	W	0
Operating ambient temperature min.		°C	-25
Operating ambient temperature max.		°C	55
IEC/EN 61439 design verification			
10.2 Strength of materials and parts			
10.2.2 Corrosion resistance			
10.2.2.1 Verification of thermal stability of enclosures			Meets the product standard's requirements.
10.2.2.2 Verification of resistance of insulating materials to normal heat			Meets the product standard's requirements.
10.2.2.3 Verification of resistance of insulating materials to abnormal heat and fire due to internal electric effects			Meets the product standard's requirements.
10.2.4 Resistance to ultra-violet (UV) radiation			Meets the product standard's requirements.
10.2.5 Lifting			Does not apply, since the entire switchgear needs to be evaluated.
10.2.6 Mechanical impact			Does not apply, since the entire switchgear needs to be evaluated.
10.2.7 Inscriptions			Meets the product standard's requirements.
10.3 Degree of protection of ASSEMBLIES			
10.4 Clearances and creepage distances			
10.5 Protection against electric shock			
10.6 Incorporation of switching devices and components			
10.7 Internal electrical circuits and connections			
10.8 Connections for external conductors			
10.9 Insulation properties			
10.9.2 Power-frequency electric strength			Is the panel builder's responsibility.
10.9.3 Impulse withstand voltage			Is the panel builder's responsibility.
10.9.4 Testing of enclosures made of insulating material			Is the panel builder's responsibility.
10.10 Temperature rise			
10.11 Short-circuit rating			
10.12 Electromagnetic compatibility			
10.13 Mechanical function			

Technical data ETIM 7.0

Low-voltage industrial components (EG000017) / Motor protection circuit-breaker (EC000074)			
Electric engineering, automation, process control engineering / Low-voltage switch technology / Circuit breaker (LV < 1 kV) / Motor protection circuit-breaker (ecl@ss10.0.1-27-37-04-01 [AGZ529016])			
Overload release current setting	A		4 - 6.3
Adjustment range undelayed short-circuit release	A		98 - 98
With thermal protection			Yes
Phase failure sensitive			Yes
Switch off technique			Thermomagnetic
Rated operating voltage	V		690 - 690

Rated permanent current I _u	A	6.3
Rated operation power at AC-3, 230 V	kW	1.1
Rated operation power at AC-3, 400 V	kW	2.2
Type of electrical connection of main circuit		Screw connection
Type of control element		Push button
Device construction		Built-in device fixed built-in technique
With integrated auxiliary switch		No
With integrated under voltage release		No
Number of poles		3
Rated short-circuit breaking capacity I _{cu} at 400 V, AC	kA	50
Degree of protection (IP)		IP20
Height	mm	93
Width	mm	45
Depth	mm	90.5

Approvals

Product Standards		IEC/EN 60947-4-1; UL 60947-4-1; CSA - C22.2 No. 60947-4-1-14; CE marking
UL File No.		E36332
UL Category Control No.		NLRV
CSA File No.		165628
CSA Class No.		3211-05
North America Certification		UL listed, CSA certified
Specially designed for North America		No
Suitable for		Branch circuit: Manual type E if used with terminal, or suitable for group installations

Characteristics

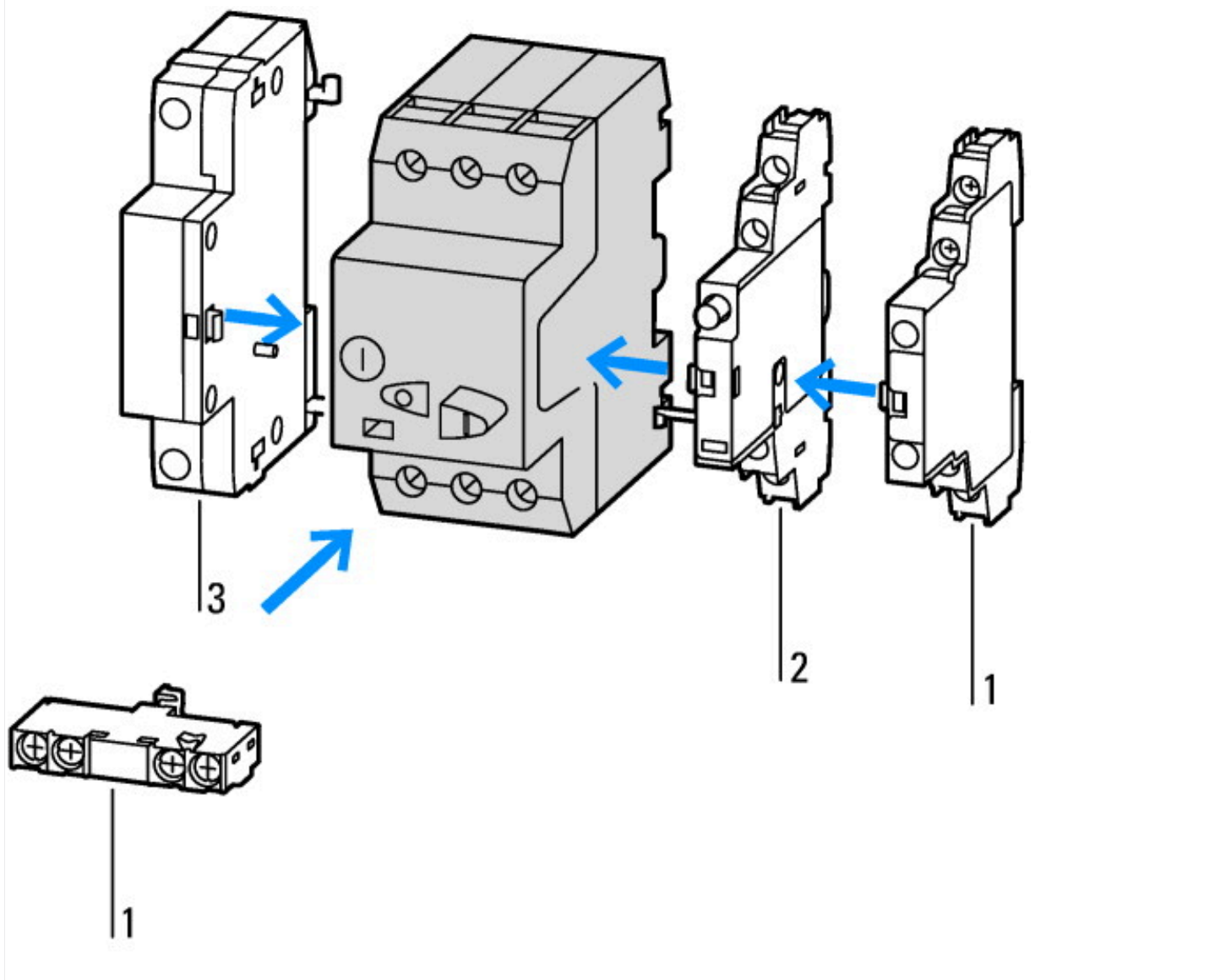

- 1: Standard auxiliary contact
- 2: Trip-indicating auxiliary contact
- 3: Shunt releases, undervoltage releases

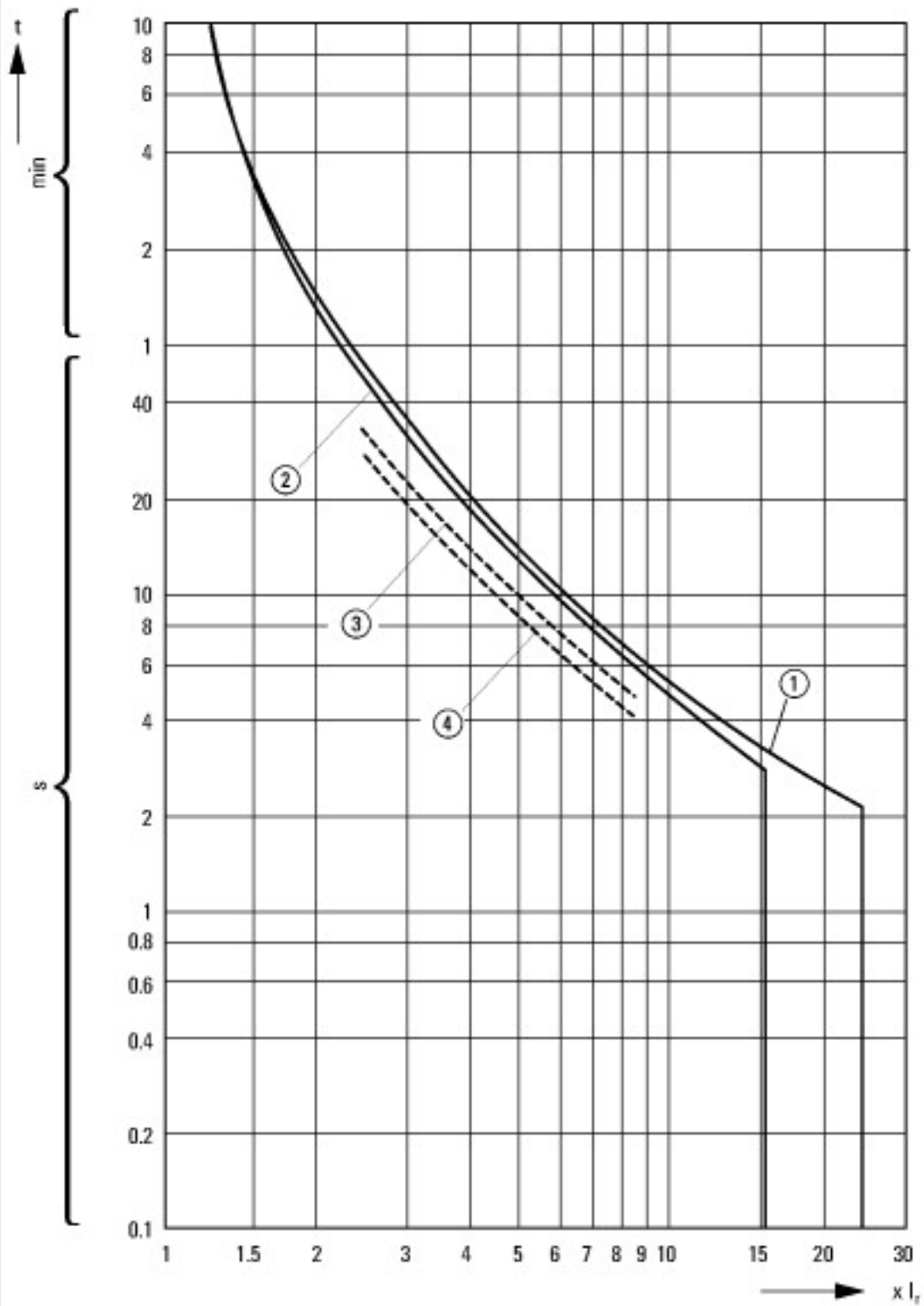

Tripping characteristics motor circuit breaker PKZM0-..., PKZM01

- 1: Minimum level, 3-phase
- 2: Maximum level, 3-phase
- 3: Minimum marker, 2-phase
- 4: Highest marker, 2-phase



Let-through current



Dimensions

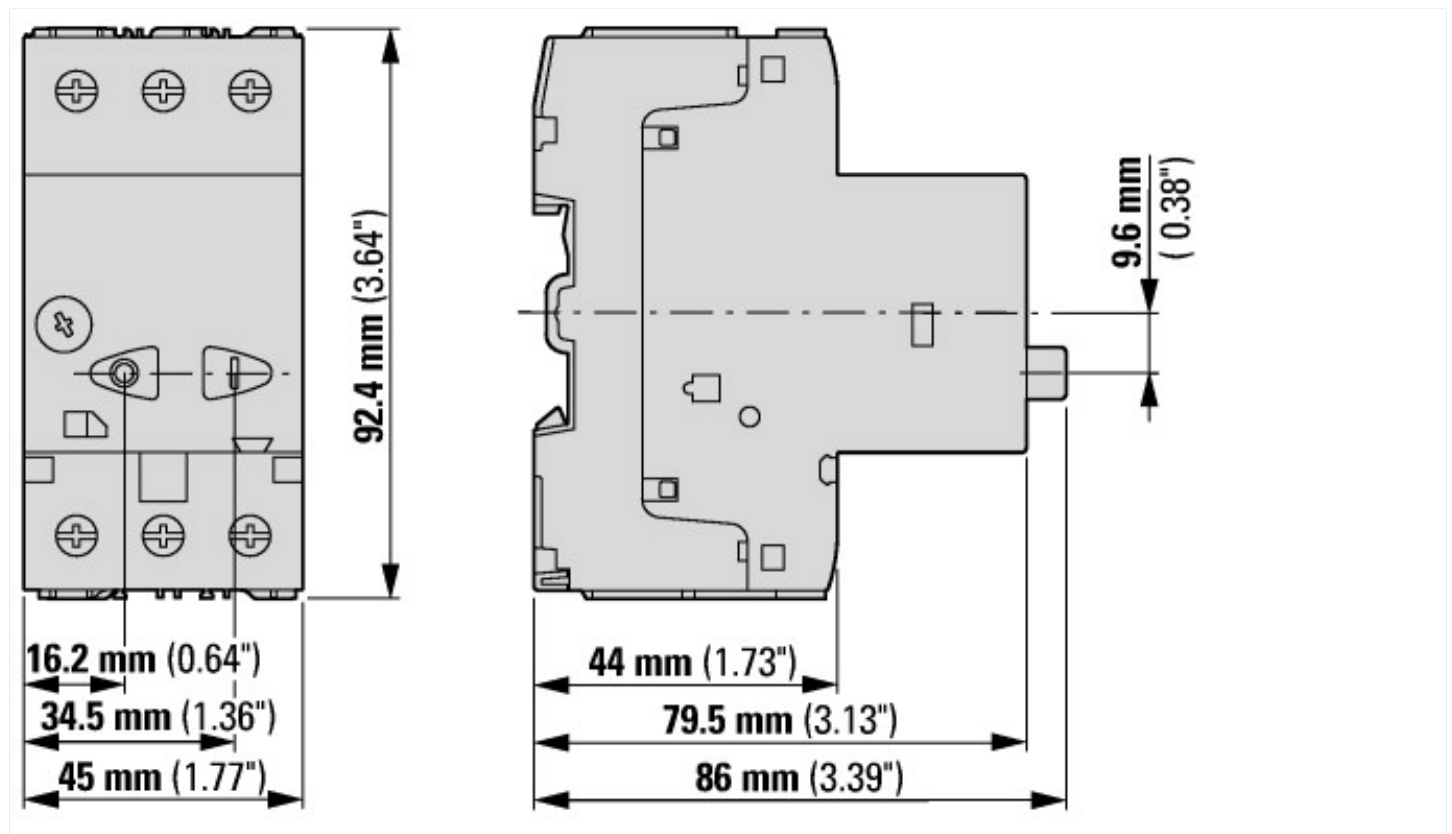

Additional product information (links)

IL03407011Z (AWA1210-1925) Motor-protective circuit-breaker	
IL03407011Z (AWA1210-1925) Motor-protective circuit-breaker	ftp://ftp.moeller.net/DOCUMENTATION/AWA_INSTRUCTIONS/IL03407011Z2018_04.pdf
IL03402034Z (AWA121-1945) Motor-protective circuit-breaker, Starter	
IL03402034Z (AWA121-1945) Motor-protective circuit-breaker, Starter	ftp://ftp.moeller.net/DOCUMENTATION/AWA_INSTRUCTIONS/IL03402034Z2018_06.pdf
Schaltvermögen	https://de.ecat.eaton.com/flip-cat/?edition=MOTCONT1_DE#page_3/45
Motor starters and "Special Purpose Ratings" for the North American market	http://www.eaton.eu/ecm/groups/public/@pub/@europe/@electrical/documents/content/pct_3258146.pdf
Busbar Component Adapters for modern Industrial control panels	http://www.moeller.net/binary/ver_techpapers/ver960en.pdf