

Overview

Features

- Continuous level measurement of solids and liquids in standard applications in nearly all industries with 80 GHz FMCW radar
- Suitable for measurement of solids in silos, segmented containers, open containers, open heaps and crushers
- Suitable for measurement of liquids in storage tanks and for water treatment
- Measurement through the wall of a plastic tank is possible as well

Measurement range

Up to 30 m (98.4 ft)

Mechanic

- Housing and antenna made of PVDF for high chemical resistance
- No aiming of the antenna is required
- Simple mounting due to threaded process connection
- Accessories for further mounting options

Service

- Plug and play system, simple installation and commissioning
- Programming / communication wireless with standard mobile device

Approvals

- Approval for use in Hazardous Locations (Dust and Gas)
- 2011/65/EU RoHS conform



Application

Solids measurement

Closed bins

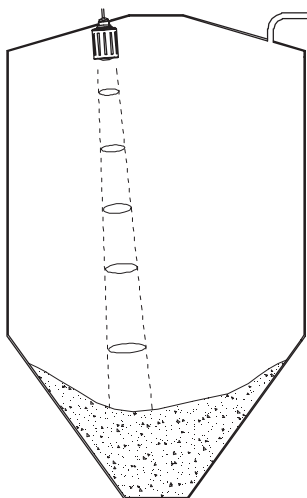

Open arrangements

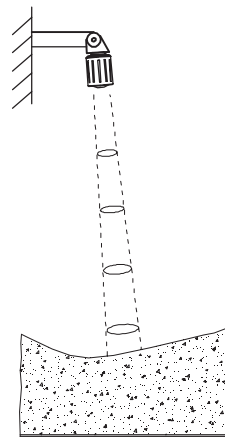

Aiming of the antenna to the center of the silo allows measurement down to the bottom

Liquids measurement

Closed bins

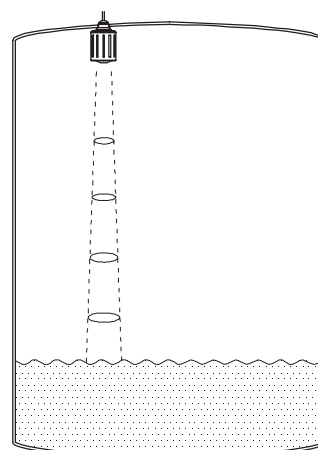

Open arrangements

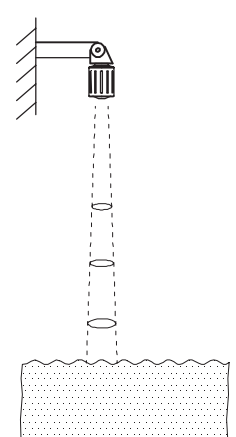

Vertical installation without aiming of the antenna

Specification

Specification

Process	Measurement range	Up to 30m (98.4 ft)
	Ambient temperature	-40 .. +80°C (-40 .. 176°F)
	Process temperature	-40 .. +80°C (-40 .. 176°F)
	Process overpressure	-1 .. +3,0 bar (-14.5 .. +43.5 psi)
Process	Frequency	80 GHz FMCW
	Beam angle	4°
	Accuracy of measurement	Solids: depending on application Liquids: ≤ 2 mm (0.08") at distance >0,25m (0.82ft)
	Response time	Max. 3 seconds (with sudden distance change)
	Dielectric constant of material measured	≥ 1,1 (under ideal conditions)
Mechanics	Ingress protection	Type 6P, IP66/68
	Antenna and process connection	Material: PVDF, FDA certification (for foodstuff and pharmaceutical)
	Connection cable	Fix mounted, colour black, with intrinsic safety:blue Material: PUR, sealing of cable inlet: Silicone
Electronics	Power supply	4-20 mA 2-wire loop according to NE43 12 .. 35 V DC
	Programming / communication	Wireless: effective range typ. 25m (82ft) HART, version 7.0 (not programmable via PACTware/DTM)
Approvals	General purpose	CE / cFMus / UKCA
	Protection by enclosure	Zone 20, 20/21: ATEX / IEC-Ex/ cFMus / UKEX / INMETRO / KCs Cl. II Div.1, Cl. III: cFMus
	Encapsulation	Zone 1, 1/2: ATEX / IEC-Ex/ cFMus / UKEX / INMETRO / KCs Cl. I Div.2: cFMus
	Non-incendive	Cl. I Div.2: cFMus
	Intrinsically safe	Zone 0, 0/1, 20, 20/21: ATEX / IEC-Ex/ cFMus / UKEX / INMETRO / KCs Cl. I Div.1, Cl. II Div.1, Cl. III: cFMus
	Radio approvals	According to country-specific standards for radar devices and wireless communication

Wireless programming / communication

with standard mobile device via UWT LevelApp:

- Tablet or Smartphone (iOS- or Android-operating system)

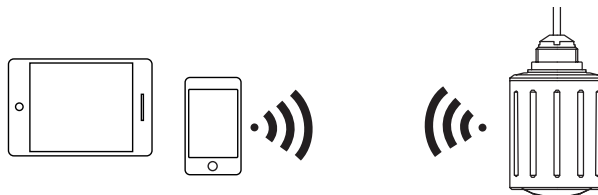

Dimensions

NR 4100

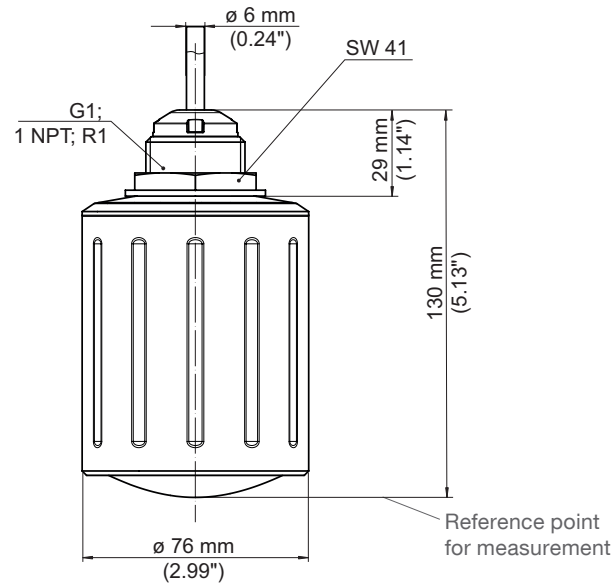

Detailed Ex-markings

pos.2 **Certificate**

T	ATEX	II 2G, Ex ib mb IIC T4 Gb II 1D, 1/2D Ex ta, ta/tb IIIC T ₂₀₀ 121°C Da, Da/Db II 2D Ex tb IIIC T ₂₀₀ 134°C Db
	IEC-Ex	Ex ib mb IIC T4 Gb Ex ta, ta/tb IIIC T ₂₀₀ 121°C Da, Da/Db Ex tb IIIC T ₂₀₀ 134°C Db
	UKEX	II 2G, Ex ib mb IIC T4 Gb II 1D, 1/2D Ex ta, ta/tb IIIC T ₂₀₀ 121°C Da, Da/Db II 2D Ex tb IIIC T ₂₀₀ 134°C Db
S	ATEX	II 1G, 1/2G Ex ia IIC T4 Ga, Ga/Gb II 1D, 1/2D Ex ia IIIC T134 °C Da, Da/Db
	IEC-Ex	Ex ia IIC T4 Ga, Ga/Gb Ex ia IIIC T134 °C Da, Da/Db
	UKEX	II 1G, 1/2G Ex ia IIC T4 Ga, Ga/Gb II 1D, 1/2D Ex ia IIIC T134 °C Da, Da/Db
	cFMus	IS Class I, Div.1, Gp.A-D, IS Class II Div.1 Gp. EFG, Cl. III T4 Class I, Zn 0, 0/1 Ex ia IIC T4 Ga, Ga/Gb Zn 20, 20/21 Ex ia IIIC T134 °C Da, Da/Db
U	cFMus	CI I Div 2 Gp ABCD T4 Ta = -20°C...+80°C AEx ib mb IIC T4 Gb Ta = -20°C to +80°C DIP Class II, Div. 1, Gp EFG, T4, Class III AEx ta IIIC (T121°C or T142°C) Da Ta = -20°C to +67°C AEx tb IIIC (T134°C or T155°C) Db Ta = -20°C to +80°C
H	cFMus	NI Class I, Div 2, Gp. A-D T4 Ta = -20°C...+80°C DIP Class II, Div 1, Gp. EFG, Cl III T4 Ta = -20°C...+80°C
F	INMETRO	Ex ia IIC T4 Ga, Ga/Gb Ex ia IIIC T134 °C Da, Da/Db
E	INMETRO	Ex ib mb IIC T4 Gb Ex ta, ta/tb IIIC T ₂₀₀ 121°C Da, Da/Db Ex tb IIIC T ₂₀₀ 134°C Db
B	KCs	Ex ia IIC T4 Ga, Ga/Gb Ex ia IIIC T134 °C Da, Da/Db
D	KCs	Ex ib mb IIC T4 Gb Ex ta, ta/tb IIIC T ₂₀₀ 121°C Da, Da/Db Ex tb IIIC T ₂₀₀ 134°C Db

Electrical installation

4-20 mA

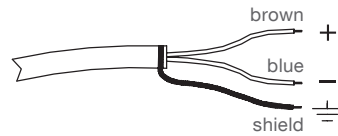

4-20 mA 2-wire loop
12 .. 35 V DC
Connecting cable 0,5 mm² (AWG 20)

With version "Intrinsically safe" (pos.2 S, X, F, B) connection is done to an approved intrinsically safe circuit (barrier):

$U_i=30\text{ V}$ $I_i=131\text{ mA}$ $P_i=983\text{mW}$

The effective internal capacitance C_i and inductance L_i depend on the length of the connection cable:

$L_i = 0,65\ \mu\text{H/m} \cdot \text{cable length in meter}$

$C_i = 180\ \text{pF/m} \cdot \text{cable length in meter}$

Extension of the cable:

Use of standard 2-wire cables. If electromagnetic interference is expected which is above the test values of EN 61326-1 for industrial areas, shielded cable should be used. Connect the cable screening to ground potential at one end on the supply side.